

# Effects of processing on fatigue crack growth and creep rupture in unplasticized polyvinyl chloride (uPVC)

HO-SUNG KIM

*Department of Mechanical Engineering, University of Newcastle, Newcastle, New South Wales 2308, Australia*

YIU-WING MAI

*Centre for Advanced Materials Technology, Department of Mechanical Engineering, University of Sydney, Sydney, New South Wales 2006, Australia*

B. COTTERELL

*Department of Mechanical and Production Engineering, National University of Singapore, Kent Ridge Crescent, Singapore 0511*

The effects of processing of unplasticized polyvinyl chloride (uPVC) pipes on fatigue-crack growth in terms of mean stress, frequency and fatigue-crack initiation, as well as on creep rupture, were investigated. No significant processing effect was observed on fatigue crack growth rates and fatigue crack initiation. However, creep rupture with three-point bending tests was significantly affected by the processing level. Two orders of magnitude difference in time to failure were found between well and poorly processed pipes caused by the large difference in the stress intensity factor at fracture instability between these pipes.

## 1. Introduction

PVC (polyvinyl chloride) is perhaps the most widely used material of all plastics. Unplasticized polyvinyl chloride (uPVC) is especially used in applications requiring moderate rigidity such as pressure pipes in water reticulation in which the pipes are often subjected to cyclic/static pressure. The pipes in this application are not only designed to withstand relatively large service stresses but are also required to have a lifetime of at least 50 years.

The mechanical performance of uPVC pipes is adversely affected by poor processing [1–5]. In a poorly processed pipe, the PVC grains and extrusion additives are not well mixed and the original “pomegranate” structure of the PVC grains, consisting of small primary particles contained in a porous skin, is not completely broken down [1]. It is the remnants of these grains that act as flaws in a pipe from which either fatigue cracks or brittle fractures initiate. There is a growing body of evidence indicating that fatigue-crack propagation initiated from the pre-existing flaws [1, 6, 7] is the main cause of most service failures. Thus, the question of how to design uPVC pipes against fatigue failure becomes important.

Gotham and Hitch [1] have reported that in unnotched samples, the number of cycles to failure, at stresses below 16 MPa, of well-processed pipes was two orders or more magnitude higher than the poorly processed pipes and, in a high stress region ( $\sigma > 28$  MPa) failure was dominated by yielding. However, in notched samples, processing did not have

any significant effect on fatigue life and virtually the same  $S-N$  curve was obtained for both well and poorly processed pipes. Therefore, it is necessary to clarify whether changes in the level of processing affect only the crack initiation component or the crack-growth component as well. Mai and Kerr [5] also investigated the processing effect on the fatigue crack growth of uPVC at one stress ratio and they showed that the crack-growth rate was slightly higher for poorly processed pipes in the transverse (extrusion) direction. Most uPVC pipes used for water reticulation, however, are subjected to an alternating pressure superimposed on a relatively constant mean pressure. Consequently, further studies on the effects of processing at different stress ratios on fatigue crack growth and on creep rupture are required.

The purpose of this paper is to provide further information about processing effects on fatigue-crack growth at different stress ratios and frequencies, and on fatigue initiation and creep rupture. These results are needed for safe design of uPVC pipes for water reticulation.

## 2 Experimental procedure

Unplasticized PVC pipes were supplied by ICI Operations Pty Ltd (Australia) and produced by Vinidex Tubemaker Pty Ltd as class 12 pipes in two diameters: 100 and 150 mm using a twin-screw extruder. The resin used was “Corvic” with an ISO K value of 67 corresponding to an approximate molecular weight

average of 170 000. The 100 mm pipes with two levels of processing were used in the cyclic fatigue experiments. The pipes were thus classified as nominally well and poorly processed pipes and their methylene chloride temperatures (MCT) were found to be 29 and 15 °C, respectively. Single-edge notched specimens (SEN) of 70 mm × 200 mm were cut in the longitudinal (axial) or transverse (hoop) direction of the flattened pipes. A longitudinal specimen was one loaded in the extrusion direction and a transverse specimen in the direction perpendicular to the extrusion.

Fatigue-crack initiation and crack-propagation experiments were conducted at room temperature in a Shimadzu closed-loop hydraulic servo pulser. All the fatigue-crack growth was monitored by a computerized data acquisition system based on a screen print of a conductive grid on the specimen. The details and accuracies of the technique have already been described by Mai and Kerr [8]. The load wave-form used was sinusoidal and the stress ratio,  $R$ , was varied from 0.03–0.47 to study the mean stress effect. For the study of frequency effects on fatigue-crack growth, the frequencies were varied between 0.5 and 10 Hz.

To measure crack initiation, each sample was pre-notched with a new razor blade with a tip radius of about 15 μm. The crack length and number of elapsed cycles,  $N$ , were measured and used to calculate the number of cycles,  $N_i$ , required for crack initiation from

$$N_i = N - \int_{a_0}^a \frac{1}{A(\Delta K)^m} da \quad (1)$$

where  $a$  is crack length at measurement,  $a_0$  the initial crack length, and  $A$  and  $m$  are constants of the Paris power law. The frequency and stress ratio used in the crack initiation experiments were 5 Hz and 0.2, respectively. Note that  $N_i$  corresponds only to that condition of a notch tip pre-cracked by a sharp razor blade.

The 150 mm (class 12) pipes were used for the creep-rupture tests. The MCT were found to be 24 and 2 °C for these well and poorly processed pipes, respectively. The three-point bend creep specimens were cut from the pipes without flattening, thus giving C-shaped specimens. Fig. 1 shows the specimen and the loading configuration. The radii of the crack tip were kept within 16 μm by machining with a sharp fly cutter.  $K_I$

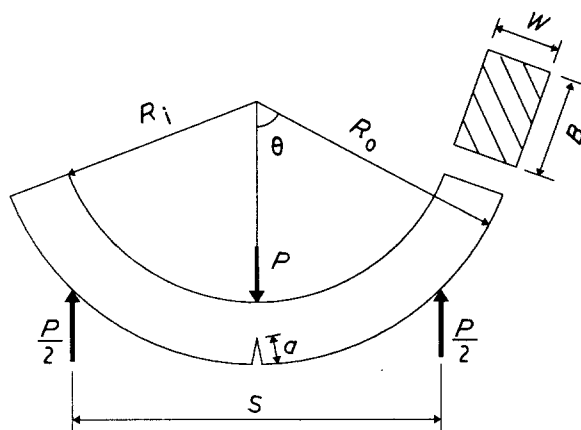

Figure 1 Three-point bending specimen for creep rupture test.

values for the C-shaped specimens were calculated using [9]

$$K_I = \frac{P \tan \theta}{R_o^{1/2} B} \left[ \frac{3R_i}{R_o} \left( 1 - \frac{R_i}{R_o} \right)^{-3/2} Y_1 R'^{1/2} - \frac{1}{2} \left( 1 - \frac{R_i}{R_o} \right)^{-1/2} Y_2 R'^{1/2} \right] \quad (2)$$

where  $P$  is the applied load,  $R' = a/W$ ,  $B$  the specimen thickness,  $R_i$  the inner radius, and  $R_o$  the outer diameter. Also

$$Y_1 = 1.96 - 2.75R' + 13.66(R')^2 - 23.98(R')^3 + 25.22(R')^4$$

and

$$Y_2 = 1.99 - 0.41R' + 18.70(R')^2 - 38.48(R')^3 + 53.85(R')^4$$

### 3. Results and discussion

#### 3.1. Mean stress, fatigue initiation and frequency effects

All the fatigue crack propagation data were analysed in accordance with the Paris power-law equation

$$\frac{da}{dN} = A \Delta K^m \quad (3)$$

The constants  $A$  and  $m$  are listed in Table I. Fig. 2 shows the fatigue crack growth rates (FCGR) versus  $\Delta K$  for different stress ratios for the well-processed pipe in the transverse direction. There is a slight increase in  $da/dN$  (a maximum of two-fold increase) with increasing stress ratio, but the mean stress effect is considered insignificant.

Fig. 3 shows FCGR versus  $\Delta K$  for different stress ratios for the poorly processed pipe in the transverse direction. Again the effect of mean stress is insignificant. Fig. 4 shows plots of all the FCGRs for both pipes for all the stress ratios, and it is quite obvious that the level of processing does not have a marked influence. These findings are generally in agreement with those of Gotham and Hitch [1] and Mai and Kerr [5].

TABLE I Paris power-law constants,  $A$  and  $m$  of  $da/dN = A \Delta K^m$  ( $da/dN$  in μm cycle<sup>-1</sup>,  $\Delta K$  in MPa m<sup>1/2</sup>)

Material	$R$	Hz	$A$	$m$	Direction
Well-processed	0.03	10	0.040	2.95	Transverse
	0.2	10	0.036	2.67	Transverse
	0.38	10	0.800	2.74	Transverse
	0.47	10	0.075	2.85	Transverse
	0.03	10	0.043	2.80	Longitudinal
	0.2	5	0.037	2.80	Longitudinal
	0.2	0.5	0.077	2.70	Longitudinal
Poorly processed	0.03	10	0.024	3.07	Transverse
	0.2	10	0.039	3.00	Transverse
	0.38	10	0.033	2.74	Transverse
	0.47	10	0.041	4.06	Transverse
	0.03	10	0.030	2.89	Longitudinal
	0.2	5	0.074	2.52	Longitudinal
	0.2	0.5	0.120	2.33	Longitudinal

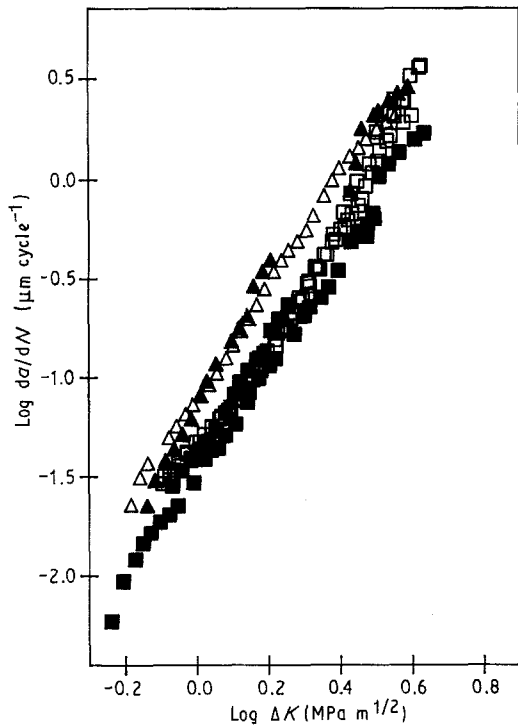

Figure 2 Fatigue-crack growth rate versus  $\Delta K$  for well-processed pipes (transverse, 100 mm) at 10 Hz.  $R$ : (□) 0.03, (■) 0.2, (△) 0.38, (▲) 0.47.

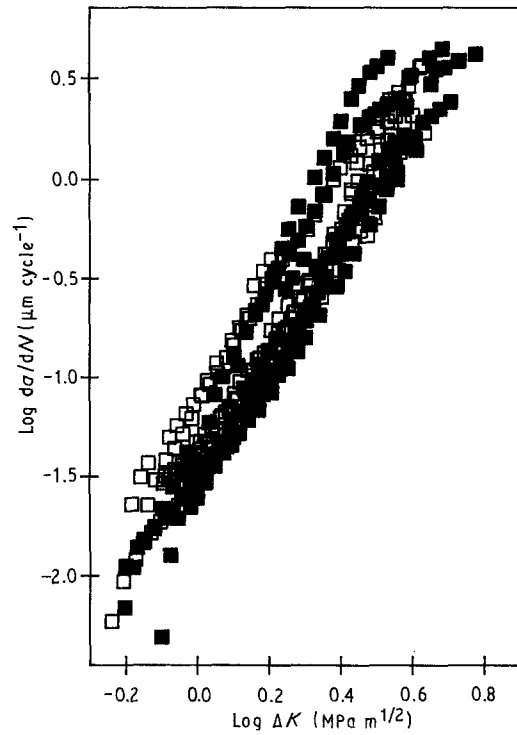

Figure 4 Comparisons of crack-growth rates at 10 Hz for both (□) well- and (■) poorly processed pipes by combining all data in Figs 2 and 3.

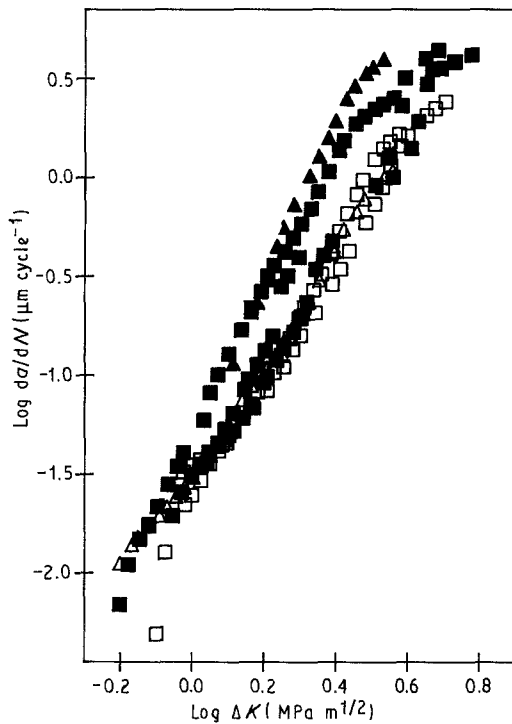

Figure 3 Fatigue-crack growth rate versus  $\Delta K$  for poorly processed pipes (transverse, 100 mm) at 10 Hz.  $R$ : (□) 0.03, (■) 0.2, (△) 0.38, (▲) 0.47.

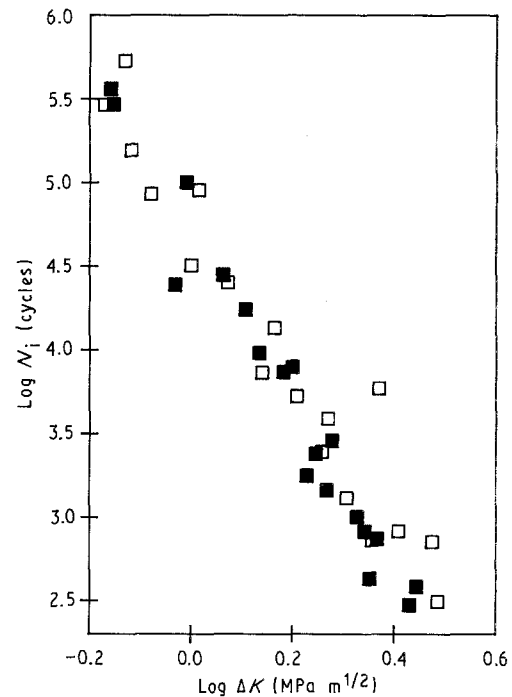

Figure 5 Number of cycles for fatigue-crack initiation versus  $\Delta K_i$  at 5 Hz and  $R = 0.2$  (longitudinal, 100 mm pipe), for (□) well- and (■) poorly processed pipes.

Fig. 5 shows a plot of the number of cycles required for fatigue crack initiation,  $N_i$ , at a given  $\Delta K$  according to Equation 1 for both well and poorly processed pipes. It is clear that there is no noticeable difference in  $N_i$  between the two processing levels and that  $N_i$  decreases almost linearly with increasing  $\Delta K$  in this log-log plot. These data are in direct disagreement with the findings of Gotham and Hitch [1] who have

suggested, based on their experimental  $S-N$  curve results using unnotched plain specimens, that changes in processing would affect the crack initiation life rather than the crack propagation life. This difference in observation could be explained as follows. In an unnotched plain specimen, cracks will initiate from inherent flaws introduced during processing and poorly processed pipes have a higher probability to

locate longer flaws than well-processed pipes. However, in a long notch specimen with a predetermined notch-tip radius, as controlled by the sharpness of the razor blade ( $\sim 15 \mu\text{m}$ ), the significance of the probability to locate large inherent flaws in a plain specimen is lost. The number of cycles to initiate a fatigue crack from the notch tip is, therefore, largely determined by the sharpness of the razor blade and is not dependent on the processing level.

With regard to the frequency effect on FCGR, Figs 6 and 7 show log-log plots of FCGR versus  $\Delta K$ , for both well- and poorly processed pipes with a frequency 10 Hz at stress ratio 0.03, 5 Hz at stress ratio 0.2, and 0.5 Hz at stress ratio 0.2. (The FCGR data from  $R = 0.03$  at 10 Hz, are included here for comparison because no significant stress ratio effect on FCGR has been found.) Generally, FCGR increases with decreasing frequency for both well- and poorly processed pipes, but this cannot be considered as significant. Comparisons of FCGRs at each frequency also show no significant effect of processing.

### 3.2. Processing effect on creep-crack growth

Three-point bending creep rupture results are plotted with the applied stress intensity factor,  $K_a$ , against  $\log t_f$  ( $t_f$  is time to failure) in Fig. 8. The well-processed pipe displays a linear relationship between  $K_a$  and  $\log t_f$  with no threshold limit yet reached at  $10^4$  h. The poorly processed pipe also displays a linear relationship up to  $10^{2.5}$  h but thereafter the data appear to level out at about  $1 \text{ MPa m}^{1/2}$  which may be the creep crack growth threshold. This threshold behaviour has not been previously reported, even though processing

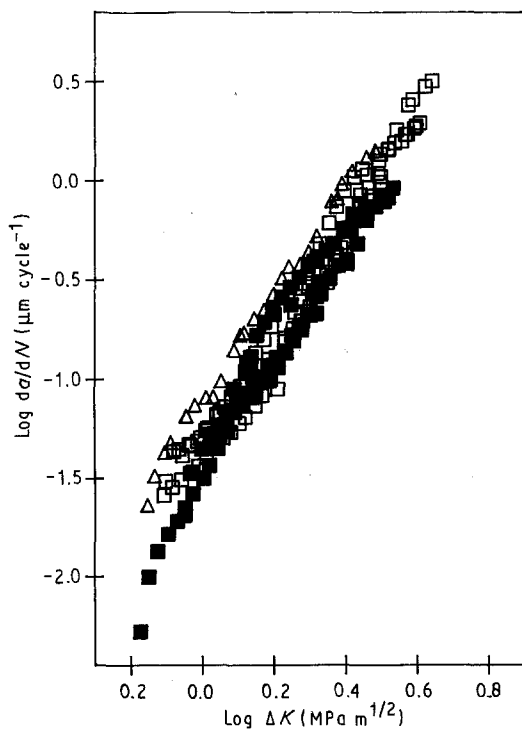

Figure 6 Frequency effect on the fatigue-crack growth rate of well-processed pipes (longitudinal). ( $\square$ ) 10 Hz,  $R = 0.03$ ; ( $\blacksquare$ ) 5 Hz,  $R = 0.2$ ; ( $\triangle$ ) 0.5 Hz,  $R = 0.2$ .

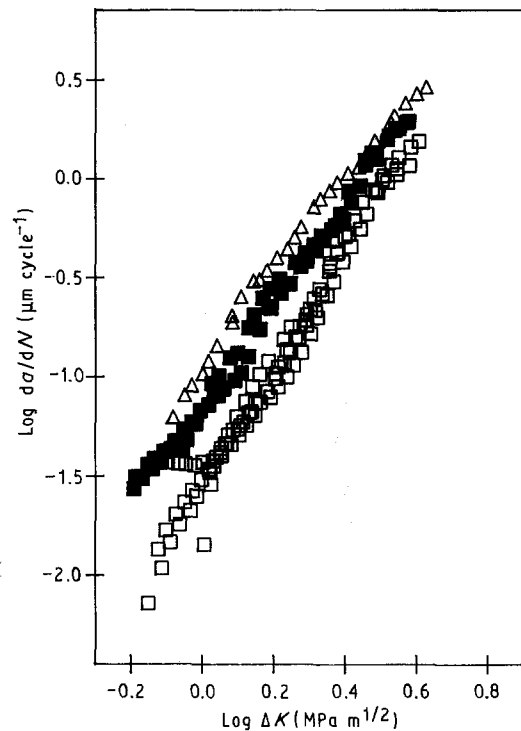

Figure 7 Frequency effect on the fatigue-crack growth rate of poorly processed pipes (longitudinal). ( $\square$ ) 10 Hz,  $R = 0.03$ ; ( $\blacksquare$ ) 5 Hz,  $R = 0.2$ ; ( $\triangle$ ) 0.5 Hz,  $R = 0.2$ .

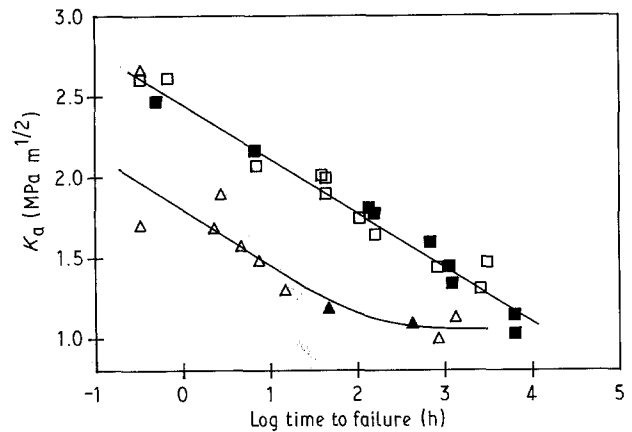

Figure 8 Applied  $K_a$  versus log time to failure,  $t_f$ , in three-point bend creep rupture test for ( $\square$ ,  $\blacksquare$ ) well- and ( $\triangle$ ,  $\blacktriangle$ ) poorly processed pipes (150 mm) in ( $\square$ ,  $\triangle$ ) air, and ( $\blacksquare$ ,  $\blacktriangle$ ) water.

effect on time to failure has been studied [10]. Note that there is a remarkable difference in times to failure at a given  $\Delta K_a$  between these two different processing levels as opposed to the fatigue-crack growth rate. Some data points collected from tests in distilled water are also included in Fig. 8, but water does not seem to affect creep-crack growth.

Fracture surfaces were examined by a stereo microscope. Figs 9–11 show fracture surfaces at  $\approx 2$ , 1.6, and  $1.3 \text{ MPa m}^{1/2}$ , respectively, for the well- and poorly processed pipes. A noticeable feature is that creep-crack growth is divided into two regions, slow and fast growths. The slow crack-growth region appears to be rough and fibrous and the fast growth region (due to fracture instability) appears to be brittle. It is interesting to note that the size of the slow crack-growth region is dependent on the processing level. At a given

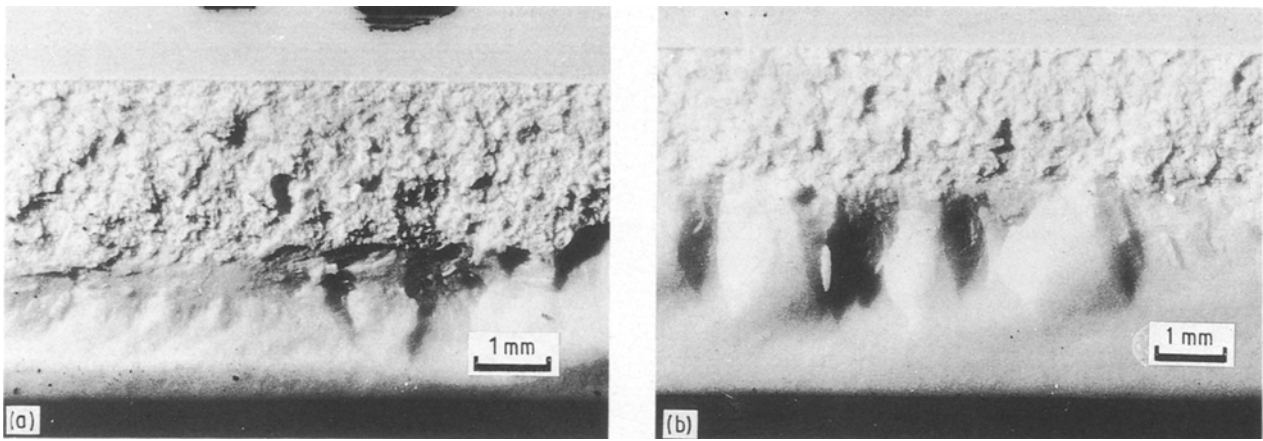

Figure 9 Fracture surfaces showing slow and fast crack-growth regions (150 mm). (a) Well-processed,  $K = 2.1 \text{ MPa m}^{1/2}$ ,  $t_f = 7 \text{ h}$ ; (b) poorly processed,  $K = 1.9 \text{ MPa m}^{1/2}$ ,  $t_f = 3 \text{ h}$ .

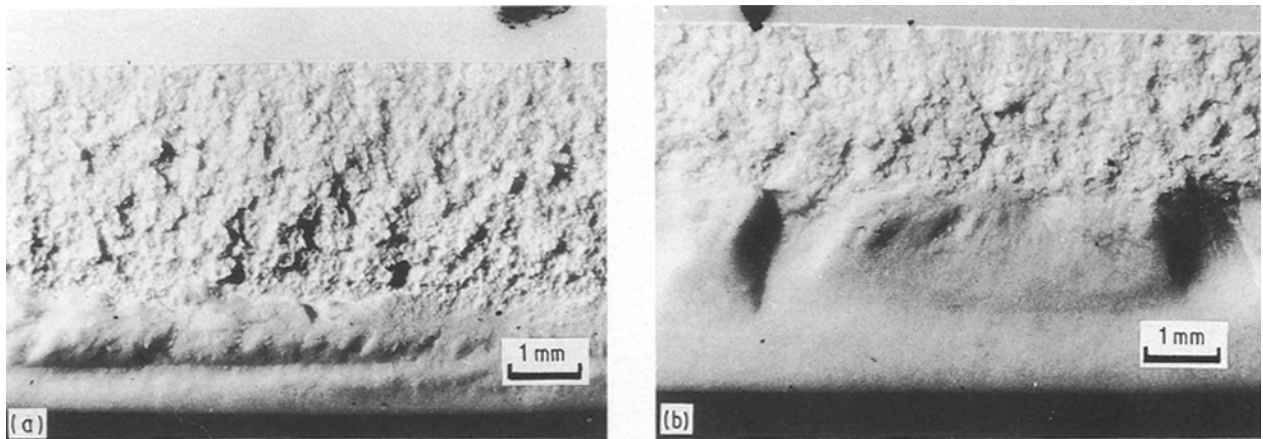

Figure 10 Fracture surfaces showing slow and fast crack-growth regions (150 mm). (a) Well-processed,  $K = 1.6 \text{ MPa m}^{1/2}$ ,  $t_f = 595 \text{ h}$ ; (b) poorly processed,  $K = 1.6 \text{ MPa m}^{1/2}$ ,  $t_f = 5 \text{ h}$ .

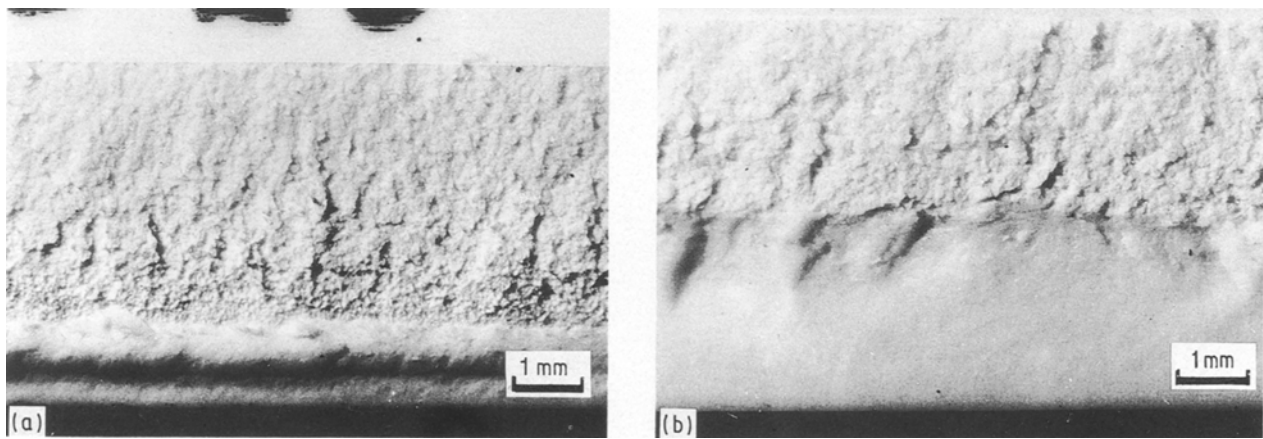

Figure 11 Fracture surfaces showing slow and fast crack-growth regions (150 mm). (a) Well-processed,  $K = 1.3 \text{ MPa m}^{1/2}$ ,  $t_f = 2587 \text{ h}$ ; (b) poorly processed,  $K = 1.3 \text{ MPa m}^{1/2}$ ,  $t_f = 15 \text{ h}$ .

$K_a$ , the slow crack-growth region of the well-processed pipe is larger than that of the poorly processed pipe and it also seems to be bigger for a smaller  $K_a$ . To quantify this observation, the stress intensity factor at the transition between the slow and fast crack-growth regions,  $K_f$ , are plotted against the applied  $K_a$  in Fig. 12. The average value of  $K_f$  was found to be

$6.83 \text{ MPa m}^{1/2}$  for the well-processed pipe and  $4.53 \text{ MPa m}^{1/2}$  for the poorly processed pipe, so that these values give a good means to distinguish the two processing levels, even though the data points are somewhat scattered. It is noted, in relation to this finding, that Mai and Kerr [5] measured fracture toughnesses of well- and poorly processed pipes at

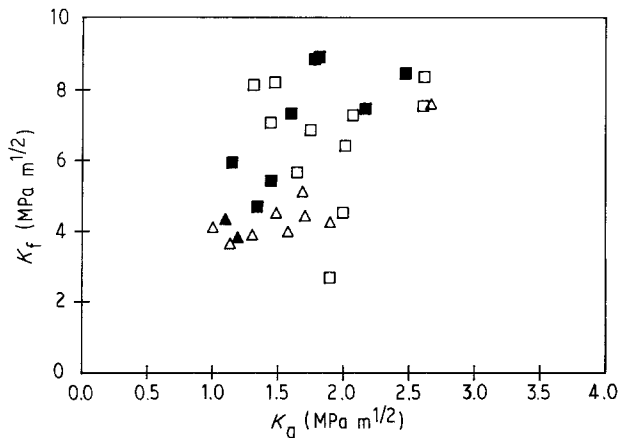

Figure 12  $K_f$  (stress intensity factor at the transition between slow and fast crack-growth regions) versus  $K_a$  for both ( $\square$ ,  $\blacksquare$ ) well- and ( $\triangle$ ,  $\blacktriangle$ ) poorly processed pipes including data ( $\blacksquare$ ,  $\blacktriangle$ ) collected from creep rupture tests in a water environment.

crack initiation and crack instability and they found that values of  $K_m$  (stress intensity factor at instability which is equivalent to  $K_f$ ) were more sensitive to the level of processing, whereas values of  $K_i$  (stress intensity factor at crack initiation) were insensitive. Thus, it is concluded that the longer time to failure,  $t_f$ , in statically loaded conditions for the well-processed pipe at a given  $K_a$  is due to its higher  $K_f$  value at crack instability. However, we do not know if the creep crack-growth rate,  $da/dt$ , is or is not affected by processing.

#### 4. Conclusion

The findings in this work have important practical implications for both designing and improving the quality of uPVC pipes. Processing does not produce any significant difference in the fatigue crack propagation rates with stress ratio,  $R$ , ranging from 0.03–0.47 at 10 Hz or with frequency ranging from 0.5–10 Hz at  $R = 0.2$  or 0.03. Nor does processing distinguish between the numbers of cycles required for fatigue-crack

initiation of long pre-cracked samples. However, the times to failure in creep-rupture tests were found to be sensitive to the level of processing. Also, values of  $K_f$  (the stress intensity factor at fracture instability) in the creep-crack growth experiments were found to be dependent on the processing level.

#### Acknowledgements

The authors thank ICI Operations Pty Ltd (Australia) for financial support of this work which was completed at the Department of Mechanical Engineering, University of Sydney. The uPVC pipes were provided for testing by Vinidex (Tubemakers) Pty Ltd. Thanks are also extended to Dr R. W. Truss, ICI, and Mr Peter Chapman, Vinidex, for useful discussions.

#### References

1. K. V. GOTHAM and M. J. HITCH, *Brit. Polym. J.* **10** (1978) 47.
2. D. R. MOORE, P. P. BENHAM, K. V. GOTHAM, M. J. HITCH and M. J. LITTLEWOOD, "The Long Term Fracture Performance of uPVC Pressure Pipe as Influenced by Processing", Proceedings of Plastic Pipes 4, March 1979, Brighton (The Plastics and Rubber Institute, 1979), paper 27, p. 27.1.
3. D. R. MOORE, R. C. STEPHENSON and M. WHALE, "Some Factors Affecting Toughness in uPVC Pipe Materials", Proceedings of Plastic Pipes V, September 1982, York (The Plastics and Rubber Institute, 1982) paper 19, p. 19.1.
4. G. P. MARSHALL and M. W. BIRCH, *Plast. Rubber Applic.* **2** (1982) 369.
5. Y.-W. MAI and P. R. KERR, *J. Vinyl Technol.* **7** (1985) 131.
6. M. A. CHRISTIE and B. PHELPS, *Int. J. Fatigue* **6** (1984) 125.
7. J. J. STAPEL, *Pipes Pipelines Int.* February (1977) 11.
8. Y.-W. MAI and P. R. KERR, *J. Mater. Sci.* **20** (1985) 2199.
9. C. S. LEE and M. M. EPSTEIN, *Polym. Engng Sci.* **22** (1982) 549.
10. R. W. TRUSS, *Pure Appl. Chem.* **57** (1985) 993.

Received 19 October  
and accepted 19 November 1992